

Avide LED Milky Filament Globe 8W E27 NW 4000K

Product code: ABLFG27NW-8W-M
Brand link: avidelighting.com/qr/ABLFG27NW-8W-M
ID: AB-190518
Company name: Bramcke Hungary Kft.
Company address: Kishatár utca 17., 4031 Debrecen



Date of issue: 2024-04-23

Page: 1/3

SPECIFICATIONS

EAN code: 5999097907604
Warranty: 3year(s)
Socket: E27
Working temperature: -20 - +40 °C
Packaging: 1/b 100/c 2500/p
Certifications: CE

TECHNICAL DETAILS

Wattage: 8W
Voltage: 220-240V
Beam angle: 360°
Dimmability: No
Lumen output: 820lm
Color temperature: 4 000K
Lifetime: 25 000h
Energy class: F
Type of LED: Filament
CRI: 80
IP standard: IP20

BOX PICTURE



Avide LED Milky Filament Globe 8W E27 NW 4000K

Product code: ABLFG27NW-8W-M
Brand link: avidelighting.com/qr/ABLFG27NW-8W-M
ID: AB-190518
Company name: Bramcke Hungary Kft.
Company address: Kishatár utca 17., 4031 Debrecen



Date of issue: 2024-04-23

Page: 2/3

PRODUCT SIZE

Diameter: 60mm
Height: 105mm

CARDBOARD BOX

EAN: 5999097907604
Packaging: 1/b 100/c 2500/p
Dimensions: 62mm x 62mm x 145mm
Net weight: 37g
Gross weight: 43g

CARTON

EAN: 5999097907611
Packaging: 1/b 100/c 2500/p
Dimensions: 640mm x 320mm x 250mm
Net weight: 3.7kg
Gross weight: 4.3kg

PALLET EXAMPLE

Height: 162.5cm
Width: 120cm (std Euro pallet)
Depth: 80cm (std Euro pallet)
Cartons per pallet: 25carton/pallet
Cartons per row: 5pcs
Net weight: 92.5kg
Gross weight: 107.5kg

PRODUCT PICTURE



PRODUCT OUTLINE

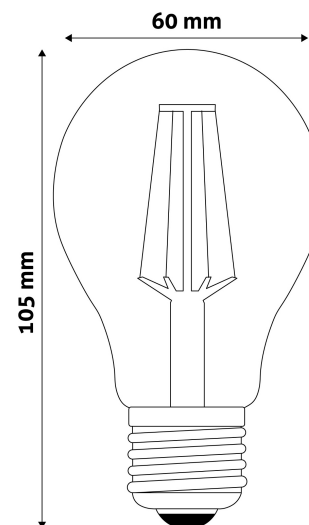

Avide LED Milky Filament Globe 8W E27 NW 4000K

Product code:	ABLFG27NW-8W-M
Brand link:	avidelighting.com/qr/ABLFG27NW-8W-M
ID:	AB-190518
Company name:	Bramcke Hungary Kft.
Company address:	Kishatár utca 17., 4031 Debrecen



Date of issue: 2024-04-23

Page: 3/3

PRODUCT DESCRIPTION

The LED filament products are professionally-designed light sources that can be used to effectively replace traditional light bulbs in most lighting environments.

This vertical line arrangement not only provides high brightness but can also produce a 360 ° projection angle. The advantages of LED lights are clearly visible here, their heat dissipation is low, thus they do not produce unnecessary heat energy, they emit light with maximum efficiency and thus can also be used at places where heating might represent a hazard.

Placement within the lamp shade or higher is the adequate choice for a transparent product. In the case of a transparent product, avoid direct lighting and at such places use types with an opaline shade instead, which provides a pleasant homogeneous light and does not dazzle the eyes.

As opposed to traditional LED technology, in the case of filament products the chips are placed on transparent columns separated from each other and are then covered with phosphorus. This is called COG or Chip on Glass technology. This procedure enables the replacement of traditional light bulbs both aesthetically and in terms of size. They do not flash, sparing they eyes this way. Switching them on and off does not shorten their service life. As they do not contain a filament per se, vibration or shock does not necessarily result in the failure of the light source.

LED lights do not emit light by heating up a metal filament but by means of electrons, thus they have a minimal heat loss. You can save up to 80% energy compared to traditional light bulbs when using LED technology. LED lights produce minimal heat, thus they can also be used at places where heating might represent a hazard.